

IEC Appliance Inlet C14 with Filter, Fuseholder 1- or 2-pole (5x20 mm or 6.3x32 mm), Line Switch 1- or 2-pole, Voltage Selector (Step)



See below:

[Approvals and Compliances](#)

**Description**

- Panel mount :  
Screw-on mounting front side
- 5 Functions :  
Appliance Inlet , Line Switch , Fuseholder with interchangeable fuse drawer for Fuse-links 5x20 mm or 6.3x32 mm , with or without voltage selector (step switch) , Line filter in standard and medical version
- V-Lock notch standard
- Quick connect terminals 4.8 x 0.8 mm

**Unique Selling Proposition**

- Multifunctional Power Entry Module
- Solid metal flange
- Various fuse drawers
- Slim design

**Characteristics**

- All single elements are already wired
- The fuse drawer "Fingerrip" can be removed by hand
- For applications according IEC/UL 62368-1 we recommend variants with bleed resistor
- Suitable for use in medical equipment according to IEC/UL 60601-1 (1 MOOP, 1 MOPP)

**References**

Alternative: version without line filter [KD](#)

**Weblinks**

[pdf data sheet](#), [html datasheet](#), [General Product Information](#), [Approvals](#), [Distributor-Stock-Check](#), [Accessories](#), [Detailed request for product](#)

**Technical Data**

|                                 |   |                                   |  |
|---------------------------------|---|-----------------------------------|--|
| Ratings IEC                     | 1 - 10A @ Ta 40 °C / 250 VAC; 50Hz  | Appliance inlet/-outlet           | C14 acc. to IEC 60320-1, UL 498, CSA C22.2 no. 42 (for cold conditions) pin-temperature 70 °C, 10A, Protection Class I |
| Ratings UL/CSA                  | 1 - 10A @ Ta 40 °C / 250 VAC; 60Hz  | Fuseholder                        | 1-/2-pole, Shocksafe category PC2 acc. to IEC 60127-6, for fuse-links 5 x 20 / 6.3 x 32mm                              |
| Leakage Current                 | standard < 0.5 mA (250 V / 60 Hz)<br>medical < 5 µA (250 V / 60 Hz)         | Rated Power Acceptance @ Ta 23 °C | 5 x 20: 2.5W (1 pole)/ 2W (2-pole) per pole<br>6.3 x 32: 3.15W (1 pole)/ 2.5W (2-pole) per pole                        |
| Dielectric Strength             | > 1.7 kVDC between L-N<br>> 2.7 kVDC between L/N-PE<br>Test voltage (2 sec) | Power Acceptance @ Ta > 23°C      | Admissible power acceptance at higher ambient temperature see derating curves  |
| Allowable Operation Temperature | -25 °C to 85 °C   | Line Switch                       | 2-pole, non-illuminated, acc. to IEC 61058-1<br><a href="#">Technical Details</a>                                      |
| Climatic Category               | 25/085/21 acc. to IEC 60068-1   | Voltage Selector                  | optional, step, 2-4 digits   |
| IP-Protection                   | front side IP40 acc. to IEC 60529   | Line Filter                       | Standard and Medical Version, IEC 60939, UL 1283, CSA C22.2 no. 8<br><a href="#">Technical Details</a>                 |
| Protection Class                | Suitable for appliances with protection class I acc. to IEC 61140           | MTBF                              | > 1'200'000h acc. to MIL-HB-217 F  |
| Terminal                        | Quick connect terminals 4.8 x 0.8 mm  |                                   |  |
| Panel Thickness S               | Screw: max 8 mm<br>Mounting screw torque max 0.5 Nm                         |                                   |  |
| Material                        | Thermoplastic, black, UL 94V-0  |                                   |  |

**Approvals and Compliances**



Detailed information on product approvals, code requirements, usage instructions and detailed test conditions can be looked up in [Details about Approvals](#)

SCHURTER products are designed for use in industrial environments. They have approvals from independent testing bodies according to national and international standards. Products with specific characteristics and requirements such as required in the automotive sector according to IATF 16949, medical technology according to ISO 13485 or in the aerospace industry can be offered exclusively with customer-specific, individual agreements by SCHURTER.

## Approvals









The approval mark is used by the testing authorities to certify compliance with the safety requirements placed on electronic products.

Approval Reference Type: CD

| Approval Logo  | Certificates                  | Certification Body | Description   |
|--|-------------------------------|--------------------|---|
|  | <a href="#">VDE Approvals</a> | VDE                | Certificate Number: 40004665 (FKSO, FKSP, FKSU, FKSV) |
|  | <a href="#">UL Approvals</a>  | UL                 | UR File Number: E72928 (FKSO, FKSP, FKSU, FKSV)       |



## Product standards

Product standards that are referenced

| Organization   | Design                | Standard         | Description   |
|--|-----------------------|------------------|---|
|  | Designed according to | IEC 60320-1      | Appliance couplers for household and similar general purposes         |
|  | Designed according to | IEC 60939        | Passive filters for suppressing electromagnetic interference          |
|  | Designed according to | IEC 60127-6      | Miniature fuses. Part 6. Fuse-holders for miniature fuse-links        |
|  | Designed according to | IEC 61058-1      | Switches for appliances. Part 1. General requirements                 |
|  | Designed according to | UL 498           | Standard for Attachment Plugs and Receptacles                         |
|  | Designed according to | UL 1283          | Passive filters for suppressing electromagnetic interference          |
|  | Designed according to | CSA C22.2 no. 42 | General Use Receptacles, Attachment Plugs, and Similar Wiring Devices |
|  | Designed according to | CSA C22.2 no. 8  | Electromagnetic interference (EMI) filters                            |









## Application standards

Application standards where the product can be used

| Organization   | Design                         | Standard       | Description  |
|--|--------------------------------|----------------|--|
|  | Suitable for applications acc. | IEC/UL 62368-1 | Audio/video, information and communication technology equipment - Part 1: Safety requirements  |
|  | Suitable for applications acc. | IEC 60601-1    | Medical electrical equipment - Part 1: General requirements for basic safety and essential performance   |
|  | Suitable for applications acc. | IEC 60335-1    | Safety of electrical appliances for household and similar purposes. Meets the requirements for appliances in unattended use. This includes the enhanced requirements of glow wire tests acc. to IEC 60695-2-11 or -12 & -13. |

## Compliances

The product complies with following Guide Lines

| Identification   | Details  | Initiator   | Description  |
|--|--|-------------|--|
|  | <a href="#">CE declaration of conformity</a>   | SCHURTER AG | The CE marking declares that the product complies with the applicable requirements laid down in the harmonisation of Community legislation on its affixing in accordance with EU Regulation 765/2008.                        |
|  | <a href="#">UKCA declaration of conformity</a> | SCHURTER AG | The UKCA marking declares that the product complies with the applicable requirements laid down in the British Amendment of Regulation (EC) 765/2008.   |
|  | RoHS   | SCHURTER AG | Directive RoHS 2011/65/EU, Amendment (EU) 2015/863   |
|  | China RoHS                                     | SCHURTER AG | The law SJ / T 11363-2006 (China RoHS) has been in force since 1 March 2007. It is similar to the EU directive RoHS.   |
|  | REACH  | SCHURTER AG | On 1 June 2007, Regulation (EC) No 1907/2006 on the Registration, Evaluation, Authorization and Restriction of Chemicals 1 (abbreviated as "REACH") entered into force.  |
|  |  | SCHURTER AG | V-Lock system are based on a matching plug-dose combination. The connector is equipped with a notch intended for use with the latching cordset. The cord latching system prevents against accidental removal of the cordset. |
|  | White Paper Glow wire test                     | SCHURTER AG | Meets the requirements of IEC 60335-1 for appliances in unattended use. This includes the enhanced requirements of glow wire tests acc. to IEC 60695-2-11 or -12 & -13.  |
|  | Medical Equipment                              | SCHURTER AG | Suitable for use in medical equipment according to IEC/UL 60601-1 (1 MOOP, 1 MOPP)   |

**Dimension [mm]**  
 CD

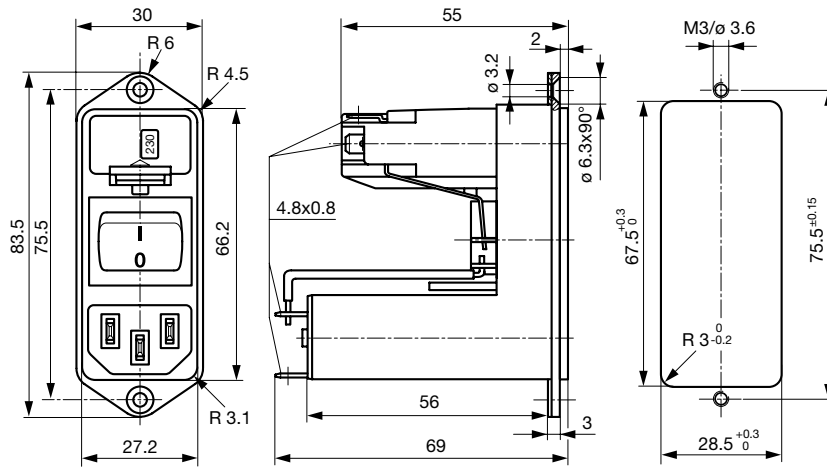

**Technical Data of Filter-Components**

| Rated Current [A] | Filter-Type           | Inductances L [mH] | Capacitance CX [nF] | Capacitance CY [nF] | R [MΩ] |
|-------------------|-----------------------|--------------------|---------------------|---------------------|--------|
| 1                 | Standard version      | 2 x 10             | 68                  | 2.2                 | -      |
| 2                 | Standard version      | 2 x 4              | 68                  | 2.2                 | -      |
| 4                 | Standard version      | 2 x 1.5            | 68                  | 2.2                 | -      |
| 6                 | Standard version      | 2 x 0.8            | 68                  | 2.2                 | -      |
| 10                | Standard version      | 2 x 0.3            | 68                  | 2.2                 | -      |
| 1                 | Medical Version (M5)  | 2 x 10             | 68                  | -                   | 1      |
| 2                 | Medical Version (M5)  | 2 x 4              | 68                  | -                   | 1      |
| 4                 | Medical Version (M5)  | 2 x 1.5            | 68                  | -                   | 1      |
| 6                 | Medical Version (M5)  | 2 x 0.8            | 68                  | -                   | 1      |
| 10                | Medical Version (M5)  | 2 x 0.3            | 68                  | -                   | 1      |
| 2                 | Medical Version (M80) | 2 x 4              | 68                  | 0.47                | 1      |
| 4                 | Medical Version (M80) | 2 x 1.5            | 68                  | 0.47                | 1      |
| 10                | Medical Version (M80) | 2 x 0.3            | 68                  | 0.47                | 1      |

**Diagrams**

Standard version

Medical Version (M5)

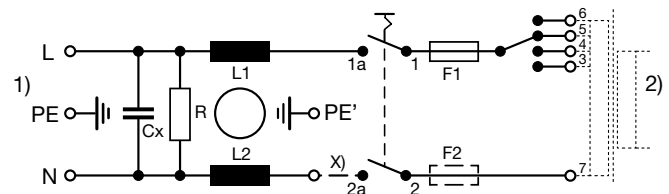
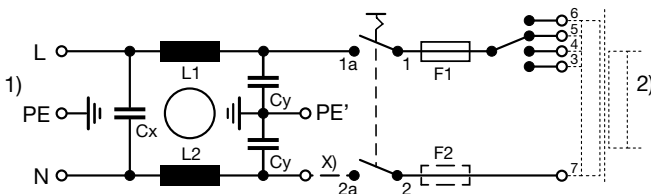

- 1) Line
- 2) Load
- x) External connection to be made by the customer

- 1) Line
- 2) Load
- x) External connection to be made by the customer

**Derating Curves**

**Fuses**

5 x 20 mm (1-pole)

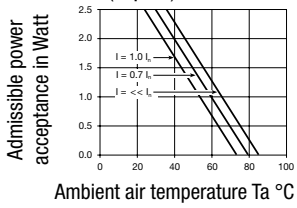

**Fuses**

5 x 20 mm (2-pole, per pole)

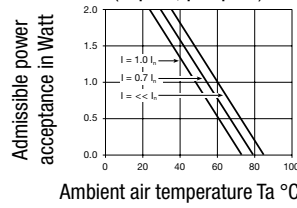

**Fuses**

6.3 x 32 mm (1-pole)

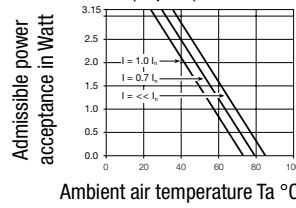

**Fuses**

6.3 x 32 mm (2-pole, per pole)

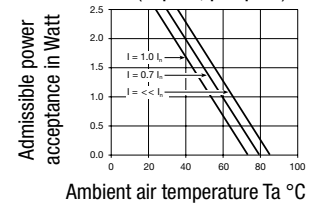

**Attenuation Loss**

--- 50Ω differential mode    \_\_\_ 50Ω common mode

Standard version

1 A

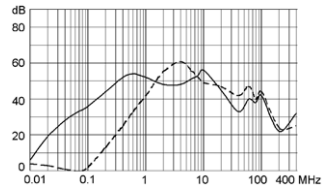

2 A

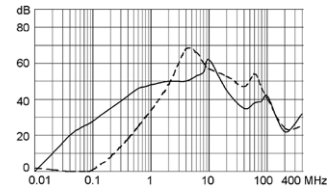

4 A

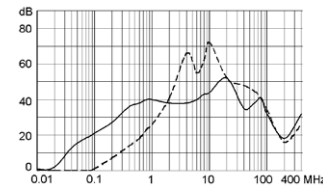

6 A

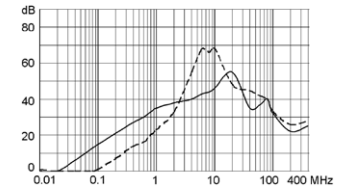

10 A

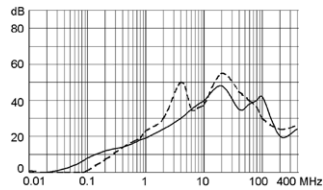

Medical version (M5)

1 A

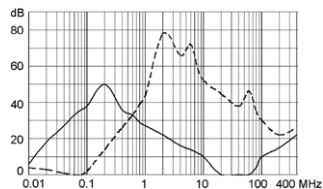

2 A

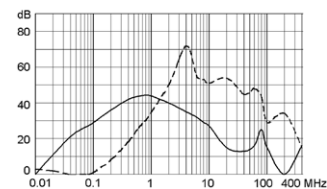

4 A

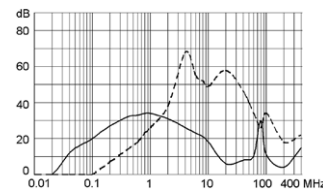

6 A

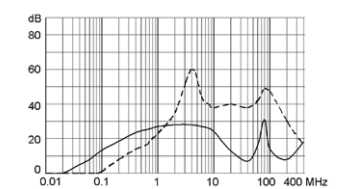

10 A

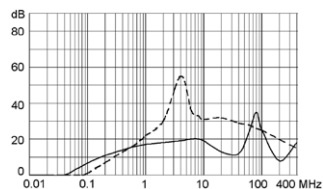

**All Variants**

| Type | Rated Current [A] | Filter-Type      | Fuseholder | Line Switch | Voltage Selector | V-Lock | Order Number  |
|------|-------------------|------------------|------------|-------------|------------------|--------|---------------|
| CD   | 1                 | Standard version | 1-pole     | 2-pole      | -                | ●      | CD11.1501.151 |
| CD   | 2                 | Standard version | 1-pole     | 2-pole      | -                | ●      | CD21.1501.151 |
| CD   | 4                 | Standard version | 1-pole     | 2-pole      | -                | ●      | CD31.1501.151 |

| Type | Rated Current [A] | Filter-Type           | Fuseholder | Line Switch | Voltage Selector | V-Lock | Order Number  |
|------|-------------------|-----------------------|------------|-------------|------------------|--------|---------------|
| CD   | 6                 | Standard version      | 1-pole     | 2-pole      | -                | ●      | CD41.1501.151 |
| CD   | 10                | Standard version      | 1-pole     | 2-pole      | -                | ●      | CD61.1501.151 |
| CD   | 1                 | Standard version      | 1-pole     | 2-pole      | 2-4 digits       | ●      | CD11.4501.151 |
| CD   | 2                 | Standard version      | 1-pole     | 2-pole      | 2-4 digits       | ●      | CD21.4501.151 |
| CD   | 4                 | Standard version      | 1-pole     | 2-pole      | 2-4 digits       | ●      | CD31.4501.151 |
| CD   | 6                 | Standard version      | 1-pole     | 2-pole      | 2-4 digits       | ●      | CD41.4501.151 |
| CD   | 10                | Standard version      | 1-pole     | 2-pole      | 2-4 digits       | ●      | CD61.4501.151 |
| CD   | 1                 | Standard version      | 2-pole     | 2-pole      | -                | ●      | CD14.1101.151 |
| CD   | 2                 | Standard version      | 2-pole     | 2-pole      | -                | ●      | CD24.1101.151 |
| CD   | 4                 | Standard version      | 2-pole     | 2-pole      | -                | ●      | CD34.1101.151 |
| CD   | 6                 | Standard version      | 2-pole     | 2-pole      | -                | ●      | CD44.1101.151 |
| CD   | 10                | Standard version      | 2-pole     | 2-pole      | -                | ●      | CD64.1101.151 |
| CD   | 1                 | Standard version      | 2-pole     | 2-pole      | 2-4 digits       | ●      | CD14.4101.151 |
| CD   | 2                 | Standard version      | 2-pole     | 2-pole      | 2-4 digits       | ●      | CD24.4101.151 |
| CD   | 4                 | Standard version      | 2-pole     | 2-pole      | 2-4 digits       | ●      | CD34.4101.151 |
| CD   | 6                 | Standard version      | 2-pole     | 2-pole      | 2-4 digits       | ●      | CD44.4101.151 |
| CD   | 10                | Standard version      | 2-pole     | 2-pole      | 2-4 digits       | ●      | CD64.4101.151 |
| CD   | 6                 | Medical Version (M5)  | 2-pole     | 2-pole      | -                | ●      | CDE4.1101.151 |
| CD   | 1                 | Medical Version (M5)  | 2-pole     | 2-pole      | 2-4 digits       | ●      | CDG4.4101.151 |
| CD   | 2                 | Medical Version (M5)  | 2-pole     | 2-pole      | 2-4 digits       | ●      | CDA4.4101.151 |
| CD   | 4                 | Medical Version (M5)  | 2-pole     | 2-pole      | 2-4 digits       | ●      | CDC4.4101.151 |
| CD   | 6                 | Medical Version (M5)  | 2-pole     | 2-pole      | 2-4 digits       | ●      | CDE4.4101.151 |
| CD   | 10                | Medical Version (M5)  | 2-pole     | 2-pole      | 2-4 digits       | ●      | CDL4.4101.151 |
| CD   | 2                 | Medical Version (M80) | 2-pole     | 2-pole      | 2-4 digits       | ●      | CDB4.4101.151 |
| CD   | 4                 | Medical Version (M80) | 2-pole     | 2-pole      | 2-4 digits       | ●      | CDD4.4101.151 |
| CD   | 10                | Medical Version (M80) | 2-pole     | 2-pole      | 2-4 digits       | ●      | CDM4.4101.151 |

Availability for all products can be searched real-time: <https://www.schurter.com/en/info-center/support-tools/stock-check-distributors>

The fuse drawer is not included and must be ordered separately (see required accessory).

**Packaging unit** 10 Pcs

**Required Accessory**

**Description**

[Fusedrawer\\_3](#)  
 Fusedrawer for Fuse Links 5x20 mm resp. 6.3x32 mm



|  |              |
|--|--------------|
| Fingergrip, 5 x 20, 2-pole, Voltage Selector                     | 4303.2014.00 |
| Fingergrip, 5 x 20, 2-pole, Voltage Selector, 100, 120, 220, 240 | 4303.2014.01 |
| Fingergrip, 5 x 20, 2-pole, Voltage Selector, 110, 150, 220      | 4303.2014.02 |
| Fingergrip, 5 x 20, 2-pole, Voltage Selector, 110, 220           | 4303.2014.03 |
| ...  |              |

Accessories



**Wire\_Harness**  
 Wire harness for SCHURTER products



**RC320**  
 Rear Cover for Power Entry Module



**Cord\_retaining\_kits**  
 Cord retaining strain relief

|              |           |
|--------------|-----------|
| Flat head, A | 4700.0001 |
|--------------|-----------|

Mating Outlets/Connectors

Category / Description

[Appliance Outlet Overview complete](#)



|  |      |
|--|------|
| 4787, Mounting: Screw-on mounting, Appliance Outlet: IEC Solder terminals, 10 A, Suitable for appliances with protection class I | 4787 |
| IEC Appliance Outlet F or H, Screw-on Mounting, Front Side, Solder, PCB or Quick-connect Terminal                                | 5091 |

[Connector Overview complete](#)



|   |         |
|---|---------|
| 4782 Mounting: Power Cord, 3 x 1 mm <sup>2</sup> / 3 x 18 AWG, Cable, Connector: IEC C13    | 4782    |
| 4785 Mounting: Power Cord, 3 x 1 mm <sup>2</sup> / 3 x 18 AWG, Cable, Connector: IEC C13    | 4785    |
| 4300-06 Mounting: Power Cord, 3 x 1 mm <sup>2</sup> / 3 x 18 AWG, Cable, Connector: IEC C13 | 4300-06 |
| 4781 Mounting: Power Cord, Cable, Connector: IEC C15  | 4781    |
| 4784 Mounting: Power Cord, 3 x 1 mm <sup>2</sup> / 3 x 18 AWG, Cable, Connector: IEC C15    | 4784    |

Mating Outlets/Connectors shuttered

[Connector Overview complete](#)



|  |      |
|--|------|
| 4783 Mounting: Power Cord, 3 x 1 mm <sup>2</sup> / 3 x 18 AWG, Cable, Connector: IEC C13 | 4783 |
|--|------|



[Power Cord Overview complete](#)

VAC13KS, Overview, V-Lock cord retaining, diverse Connector IEC C13, diverse, black

VAC13KS