

IEC Appliance Inlet C20 with Circuit Breaker TA45



Screw-on version from front or rear side  
 Rocker non-illuminated  
 white



Snap-in mounting from front side  
 Rocker illuminated  
 orange



See below:  
[Approvals and Compliances](#)

**Description**

- Panel mount :  
 Screw-on version from front or rear side, snap-in version front side
- 2 Functions :  
 Appliance Inlet Protection class I , circuit breaker type TA45 2-pole
- Quick connect terminals 6.3 x 0.8 mm

**Characteristics**

- All single elements are already wired
- Unwired versions available on request
- Circuit Breaker non-illuminated or illuminated
- Suitable for use in equipment according to IEC/UL 62368-1

**Other versions on request**

- Unwired versions
- Variant with notch for V-Lock mating Cordsets

**References**

Alternative: version with line filter [EF12](#)

**Weblinks**

[pdf data sheet](#), [html datasheet](#), [General Product Information](#), [Approvals](#), [Distributor-Stock-Check](#), [Accessories](#), [Detailed request for product](#)

Newly available variants corresponding to V-Lock mating cordset. The connector is equipped with a notch intended for use with the latching cordset. The cord latching system prevents against accidental removal of the cordset.

**Technical Data**

Ratings IEC	16A / 250VAC; 50Hz	Appliance inlet/-outlet	C20 acc. to IEC 60320-1, UL 60320-1, CSA C22.2 no. 60320-1 (for cold conditions) pin-temperature 70 °C, 16A, Protection Class I
Ratings UL/CSA	20A / 250VAC; 60Hz	Circuit Breakers	Acc. IEC/EN 60934, UL 1077, CSA 22.2 no. 235
Dielectric Strength	> 1.5kVAC between L-N > 3kVAC between L/N-PE (1 min/50Hz)		2-pole rocker switch, illuminated or non-illuminated. Optional with undervoltage- or remote trip release
Allowable Operation Temperature	-10 °C to 55 °C		Short circuit capacity Icn: at In < 3A/240VAC : 10 x In at In ≥ 3A/240VAC : 300A
IP-Protection	front side IP40 acc. to IEC 60529		
Protection against electric shock	Suitable for appliances with protection class I acc. to IEC 61140		
Terminal	Quick connect terminals 6.3 x 0.8 mm		
Panel Thickness S	Screw: max 8 mm Mounting screw torque max 0.5Nm Snap-in: 1.5/2/2.5 mm		
Material: Housing	Thermoplastic, black, UL 94V-0		

**Approvals and Compliances**



Detailed information on product approvals, code requirements, usage instructions and detailed test conditions can be looked up in [Details about Approvals](#)

SCHURTER products are designed for use in industrial environments. They have approvals from independent testing bodies according to national and international standards. Products with specific characteristics and requirements such as required in the automotive sector according to IATF 16949, medical technology according to ISO 13485 or in the aerospace industry can be offered exclusively with customer-specific, individual agreements by SCHURTER.

## Approvals



The approval mark is used by the testing authorities to certify compliance with the safety requirements placed on electronic products.

Approval Reference Type: EF11

Approval Logo	Certificates	Certification Body	Description
	<a href="#">VDE Approvals</a>	VDE	Certificate Number: 40001029
	<a href="#">UL Approvals</a>	UL	UR File Number: E96454

## Product standards

Product standards that are referenced

Organization	Design	Standard	Description
	Designed according to	IEC 60320-1	Appliance couplers for household and similar general purposes
	Designed according to	UL 60320-1	Standard for Attachment Plugs and Receptacles
	Designed according to	CSA C22.2 no. 60320-1	General Use Receptacles, Attachment Plugs, and Similar Wiring Devices







## Application standards

Application standards where the product can be used

Organization	Design	Standard	Description
	Suitable for applications acc.	IEC/UL 62368-1	Audio/video, information and communication technology equipment - Part 1: Safety requirements

## Compliances

The product complies with following Guide Lines

Identification	Details	Initiator	Description
	<a href="#">CE declaration of conformity</a>	SCHURTER AG	The CE marking declares that the product complies with the applicable requirements laid down in the harmonisation of Community legislation on its affixing in accordance with EU Regulation 765/2008.
	<a href="#">UKCA declaration of conformity</a>	SCHURTER AG	The UKCA marking declares that the product complies with the applicable requirements laid down in the British Amendment of Regulation (EC) 765/2008.
	RoHS	SCHURTER AG	Directive RoHS 2011/65/EU, Amendment (EU) 2015/863
	China RoHS	SCHURTER AG	The law SJ / T 11363-2006 (China RoHS) has been in force since 1 March 2007. It is similar to the EU directive RoHS.
	REACH	SCHURTER AG	On 1 June 2007, Regulation (EC) No 1907/2006 on the Registration, Evaluation, Authorization and Restriction of Chemicals 1 (abbreviated as "REACH") entered into force.
		SCHURTER AG	V-Lock system are based on a matching plug-dose combination. The connector is equipped with a notch intended for use with the latching cordset. The cord latching system prevents against accidental removal of the cordset.

**Dimensions [mm]**  
 Screw-on mounting

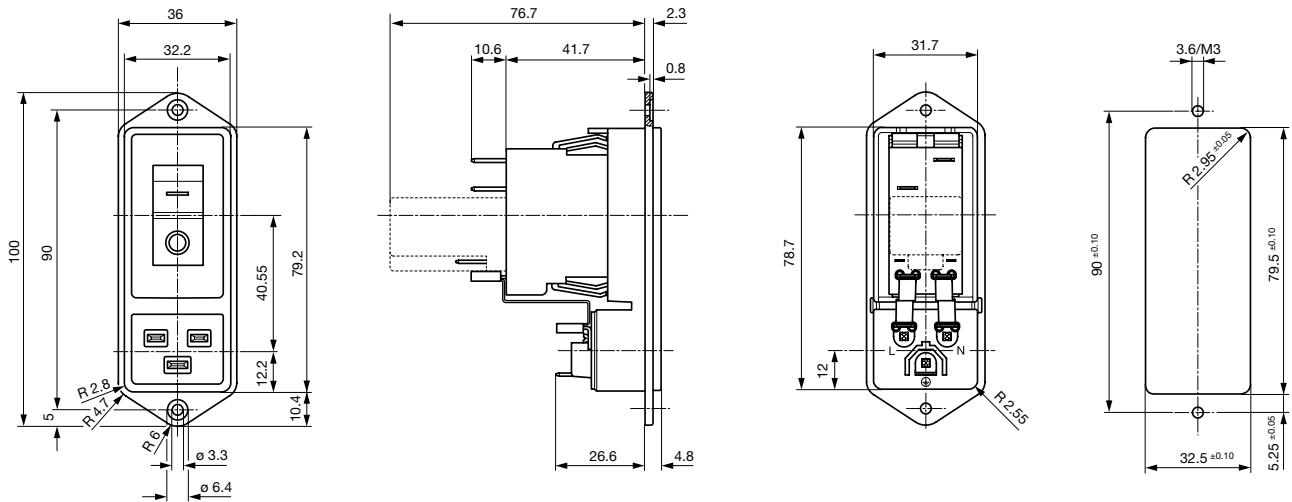

\*\* --- Version TA45 with undervoltage release

Snap-in mounting

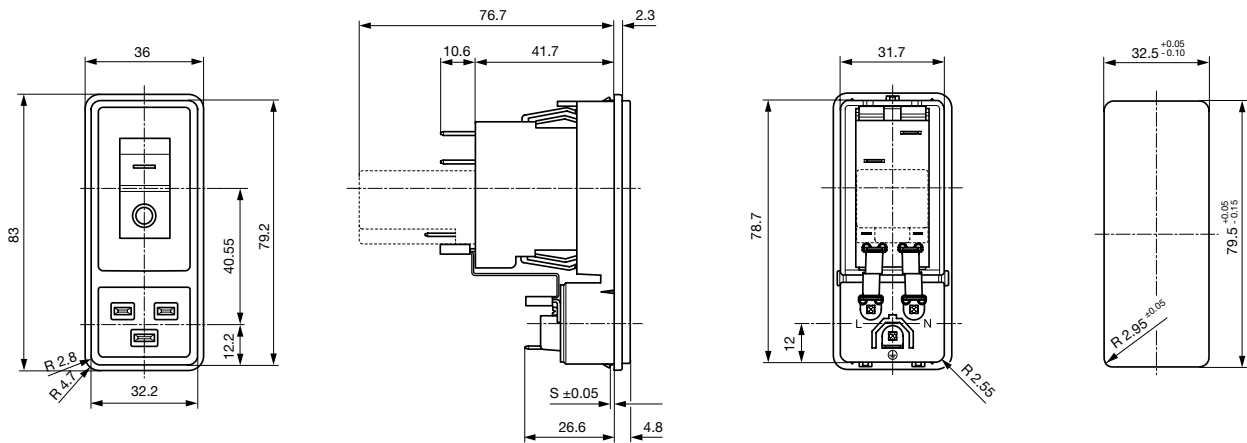

\*\* --- Version TA45 with undervoltage release

Diagrams

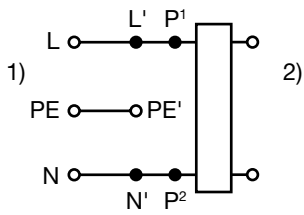

1) Line  
 2) Load

Effect of ambient temperature

The units are calibrated for an ambient temperature of +23°C. To determine the rated current for a lower or higher ambient temperature, use a correction factor (typical value) from the table below:

Ambient Temperature [°C]	Correction factor
-10	0.89
-5	0.91
0	0.92
+23	1.00
+30	1.03
+40	1.08
+55	1.16

Example: With a nominal current of 5A and an ambient temperature of 40°C, a correction factor of 1.08 results. This results in a nominal current of 5.5 A, which is rounded up to the next higher nominal current 6 A.

Time-Current-Curves

Tripping Characteristics  $I_n < 3 A$

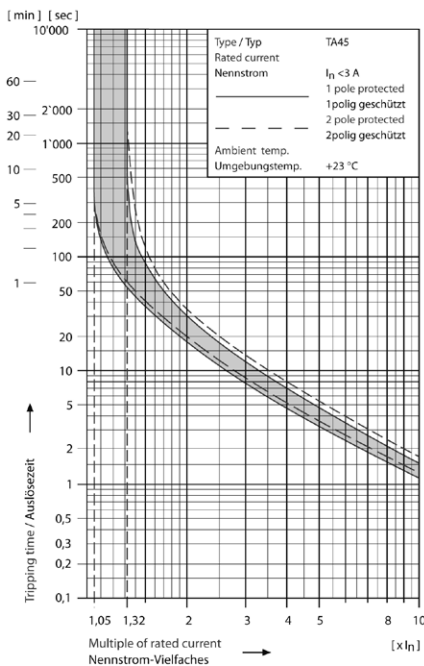

Tripping Characteristics  $I_n \geq 3 \dots < 18 A$

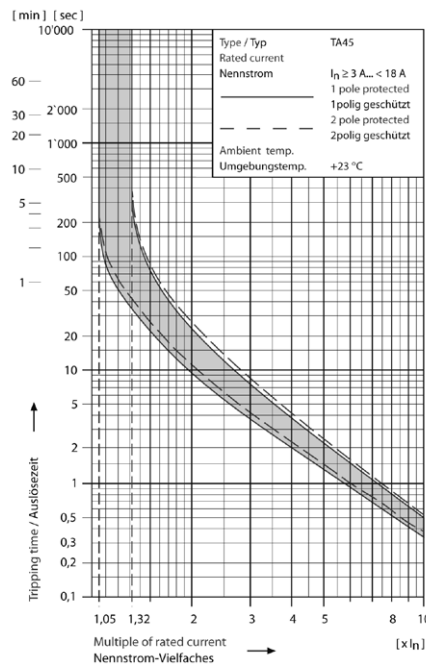

Tripping Characteristics  $I_n \geq 18\text{ A}$

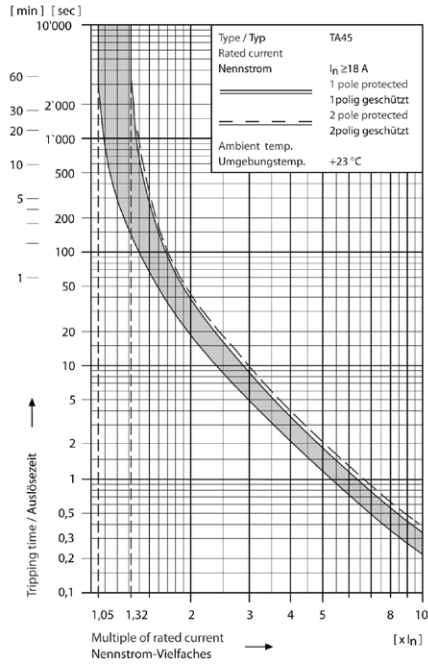

## Order number key

### Configuration code TA45

Type	Configuration code TA45										
EF11	A	B	T	W	F	1	5	0	C	0	000-111-000

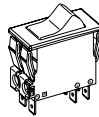

- Circuit Breaker of Equipment
  - 2-pole, rocker actuated
  - Quick connect terminal
- Other types on request

#### Without release: code C0

##### Undervoltage release

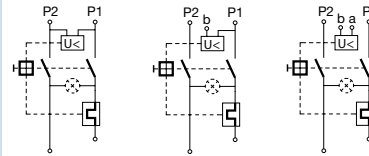

Code	Rated voltage $U_n$
•	•
•	•
•	•

##### Remote trip release

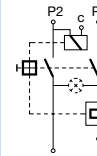

Code	Rated voltage $U_n$
•	•
•	•
•	•

#### Rated current circuit breaker of equipment

$I_n$	Code	$I_n$	Code	$I_n$	Code	$I_n$	Code
10,0	100	13,0	130	16,0	160	19,0	190
11,0	110	14,0	140	17,0	170	20,0	200
12,0	120	15,0	150	18,0	180		

Other rated currents on request

#### Rocker legend

Surface	Illustration	Colour of print
<b>F</b> embossed	— ○	
<b>H</b> printed	ON OFF	white
<b>K</b> printed	ON OFF	black
<b>L</b> printed	— ○	white
<b>M</b> printed	— ○	black
<b>P</b> printed	I ○	white
<b>R</b> printed	I ○	black

Position of the rocker legend e.g F

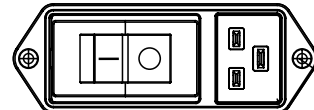

#### Colours

Switch front	Rocker
<b>W</b> black	white
<b>B</b> black	black
<b>6</b> black	— orange transp.

#### Diagram

Thermal overload protection	1-pole	2-pole
Without illumination	<b>ABT</b>	<b>ABD</b>
With illumination	<b>A12</b> <b>A14</b>	<b>A32</b> <b>A34</b>

Configuration code (Order example)

Type	Configuration code TA45			
EF11	A B T W F 1 5 0 C 0	0 0 0	1 1 1	0 0 0

**Optional Variants**

- 0 without V-Lock notch
- 9 with V-Lock notch

**Colour**

- 0 black

**Mounting**

- 0 Screw mounting
- 2 Snap-in mounting s = 1.5
- 3 Snap-in mounting s = 2.0
- 4 Snap-in mounting s = 2.5

**Terminal PE**

- 1 Quick-connect terminals 6.3x0.8mm

**Terminal N**

- 1 Quick-connect terminals 6.3x0.8mm, without connection to TA45
- 3 connection to TA45 non insulated

**Terminal L**

- 1 Quick-connect terminals 6.3x0.8mm, without connection to TA45
- 3 connection to TA45 non insulated

Variants

Rated Current CBE [A]	Rocker colour	Illumination	Diagram	Mounting	V-Lock	Internally wired	Order Number
15	orange transparent	illuminated	2-pole	Screw	●	●	3-125-296
20	orange transparent	illuminated	2-pole	Screw		●	EF11.2561.0010.01
20	orange transparent	illuminated	2-pole	Snap-in 1.5mm		●	EF11.2561.0012.01
20	orange transparent	illuminated	1-pole	Screw		●	EF11.3197.0010.01
20	black	non-illuminated	2-pole	Screw	●	●	3-109-889
15	black	non-illuminated	2-pole	Screw		●	EF11.1089.0010.01
15	black	non-illuminated	2-pole	Snap-in 2.0mm		●	EF11.1089.0013.01
15	black	non-illuminated	2-pole	Screw		●	EF11.1682.0010.01
20	black	non-illuminated	2-pole	Screw		●	EF11.1894.0010.01
10	black	non-illuminated	2-pole	Screw		●	EF11.2078.0010.01
20	black	non-illuminated	2-pole	Screw		●	EF11.2196.0010.01
20	black	non-illuminated	2-pole	Snap-in 2.0mm		●	EF11.2196.0013.01
10	white	non-illuminated	1-pole	Screw		●	EF11.0022.0010.01
20	white	non-illuminated	1-pole	Screw		●	EF11.0035.0010.01
20	white	non-illuminated	1-pole	Snap-in 1.5mm		●	EF11.0035.0012.01
10	white	non-illuminated	2-pole	Screw		●	EF11.0470.0010.01
20	white	non-illuminated	2-pole	Snap-in 1.5mm		●	EF11.0572.0012.01
16	white	non-illuminated	2-pole	Screw		●	EF11.0699.0010.01
16	white	non-illuminated	2-pole	Snap-in 2.0mm		●	EF11.0699.1013.01
15	white	non-illuminated	2-pole	Screw		●	EF11.0885.0010.01
15	white	non-illuminated	1-pole	Screw		●	EF11.2405.0010.01

Availability for all products can be searched real-time: <https://www.schurter.com/en/info-center/support-tools/stock-check-distributors>

<b>Packaging unit</b>	16 Pcs
-----------------------	--------

Accessories

Description

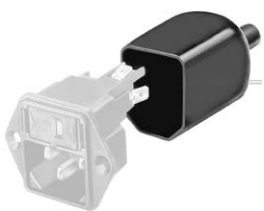

Assorted\_Covers  
Rear Cover

0859.0109



Cord\_retaining\_kits  
Cord retaining strain relief

Flat head, H

4700.0008



**Mating Outlets/Connectors**

Category / Description



[Connector Overview complete](#)

4795, Mounting: Power Cord, Cable Connector: IEC C19	4795
4790, Mounting: Power Cord, Screw Connector: IEC C19	4790
0104U, Mounting: Power Supply Cord, Screw clamps Connector: IEC C19	0104U

[Power Supply Cord Overview complete](#)



Cord Sets 10 A, North America, 3.0 m, Connector IEC C13, SJT 3x18 AWG, transparent	4300.0920
Cord Sets 16 A, Europlug, 2.5 m, Connector IEC C19, H05VV-F3G1.5, black	6004.0395
Cord Sets 16 A, Interconnection, 1.0 m, Connector IEC C19, H05VV-F3G1.5, black	6020.0392
Cord Sets 16 A, Interconnection, 2.0 m, Connector IEC C19, H05VV-F3G1.5, black	6020.0394
Cord Sets 16 A, North America, 2.5 m, Connector IEC C19, SJT 3x14 AWG, black	6009.5195

**Mating Outlets/Connectors shuttered**



[Power Cord Overview complete](#)

VAC19KS, Overview, V-Lock cord retaining, diverse Connector IEC C19, diverse, black	VAC19KS
---	---------