

Shock-Safe Fuseholder, 5 x 20 mm, Slotted Cap/Fingergrip, Snap stepless, 1.0 - 3.0 mm, IEC 60335-1



Snap-in version  
 from front side  
 horizontal with finger grip  
 fingergrip

250 VAC · 2.5W/10A (VDE) · 500V · 16A (UL/CSA)

See below:  
[Approvals and Compliances](#)

### Description

- Panel Thickness 1.0 - 3.0 mm, Snap stepless
- Compact design
- White color available on request

### Applications

- Household appliances
- Medical Equipment

### References

#### Weblinks

[pdf data sheet](#), [html datasheet](#), [General Product Information](#), [Distributor-Stock-Check](#), [Detailed request for product](#), [Microsite](#)

### Technical Data

|                            |   |
|----------------------------|---|
| Shock-Safe Category        | PC2   |
| Fuse-Link                  | 5 x 20mm  |
| Mounting                   | Panel mount, Front Side   |
| Attachment                 | Snap-in   |
| Terminal                   | Solder / Quick-Connect 4.8 x 0.5 mm   |
| Rated Voltage              | 250VAC, 500V (UL/CSA)   |
| Rated current              | 10A (VDE), 16A (UL/CSA)   |
| Rated Power Acceptance IEC | 2.5W / 10A @ Ta 23 °C   |
| Degree of Protection       | IP40  |
| Protection Class           | Suitable for appliances with protection class I acc. to IEC 61140   |
| Admissible Ambient Temp.   | -40 °C to 85 °C   |
| Climatic Category          | 40/085/21 acc. to IEC 60068-1   |
| Material: Socket           | Thermoplastic, black, UL 94V-0  |
| Material: Terminals        | Copper alloy, tin-plated  |
| Unit Weight                | 5.3 g   |
| Storage Conditions         | 0 °C to 60 °C, max. 70% r.h.  |
| Product Marking            |  Type, Rated Voltage, Power Acc./ Current Rating, Panel Thickness, Certification marks |

|                              |   |
|------------------------------|---|
| Soldering Methods            | Iron<br><a href="#">Soldering Profile</a>                 |
| Solderability                | 350 °C / 2 sec acc. to IEC 60068-2-20, Test Ta, method 2  |
| Resistance to Soldering Heat | 350 °C / 10 sec acc. to IEC 60068-2-20, Test Tb, method 2 |
| Contact Resistance           | ≤ 10 mΩ at 100 mA acc. to IEC 60127-6                     |
| Dielectric Strength          | > 3kV between live parts                                  |
| Impulse Withstand Voltage    | > 4kV between live parts                                  |
| Insulation Resistance        | ≥ 10 MΩ between live parts (500VDC: 1 min)                |
| Overvoltage Category         | III acc. to IEC 60664-1                                   |
| Pollution Degree             | 3 acc. to IEC 60664-1                                     |
| Resistance to Vibration      | acc. to IEC 60068-2-6, test Fc                            |
| Panel Thickness              | 1.0 - 3.0mm   |

### Approvals and Compliances



Detailed information on product approvals, code requirements, usage instructions and detailed test conditions can be looked up in [Details about Approvals](#)

SCHURTER products are designed for use in industrial environments. They have approvals from independent testing bodies according to national and international standards. Products with specific characteristics and requirements such as required in the automotive sector according to IATF 16949, medical technology according to ISO 13485 or in the aerospace industry can be offered exclusively with customer-specific, individual agreements by SCHURTER.

### Approvals



The approval mark is used by the testing authorities to certify compliance with the safety requirements placed on electronic products.

Approval Reference Type: FPG3

| Approval Logo  | Certificates  | Certification Body | Description                    |
|--|---------------|--------------------|--------------------------------|
|  | VDE Approvals | VDE                | VDE Certificate Number: 127216 |
|  | UL Approvals  | UL                 | UR File Number: E39328         |
|  | KTL Approvals | KTL                | Korea Testing Laboratory       |



### Product standards

Product standards that are referenced

| Organization   | Design                | Standard             | Description  |
|--|-----------------------|----------------------|--|
|  | Designed according to | IEC 60127-6          | Miniature fuses. Part 6. Fuse-holders for miniature fuse-links |
|  | Designed according to | UL 4248-1            | Industrial Control Equipment                                   |
|  | Designed according to | CSA C22.2 no. 4248.1 | Industrial Control Equipment                                   |







### Application standards

Application standards where the product can be used

| Organization  | Design                         | Standard       | Description  |
|---|--------------------------------|----------------|--|
|   | Suitable for applications acc. | IEC/UL 62368-1 | Audio/video, information and communication technology equipment - Part 1: Safety requirements  |
|  | Suitable for applications acc. | IEC 60335-1    | Safety of electrical appliances for household and similar purposes. Meets the requirements for appliances in unattended use. This includes the enhanced requirements of glow wire tests acc. to IEC 60695-2-11 or -12 & -13. |

### Compliances

The product complies with following Guide Lines

| Identification   | Details                        | Initiator   | Description   |
|--|--------------------------------|-------------|---|
|  | CE declaration of conformity   | SCHURTER AG | The CE marking declares that the product complies with the applicable requirements laid down in the harmonisation of Community legislation on its affixing in accordance with EU Regulation 765/2008. |
|  | UKCA declaration of conformity | SCHURTER AG | The UKCA marking declares that the product complies with the applicable requirements laid down in the British Amendment of Regulation (EC) 765/2008.  |
|  | RoHS                           | SCHURTER AG | Directive RoHS 2011/65/EU, Amendment (EU) 2015/863  |
|  | China RoHS                     | SCHURTER AG | The law SJ / T 11363-2006 (China RoHS) has been in force since 1 March 2007. It is similar to the EU directive RoHS.  |
|  | REACH                          | SCHURTER AG | On 1 June 2007, Regulation (EC) No 1907/2006 on the Registration, Evaluation, Authorization and Restriction of Chemicals 1 (abbreviated as "REACH") entered into force.                               |
|  | White Paper Glow wire test     | SCHURTER AG | Meets the requirements of IEC 60335-1 for appliances in unattended use. This includes the enhanced requirements of glow wire tests acc. to IEC 60695-2-11 or -12 & -13.                               |

### Dimension [mm]

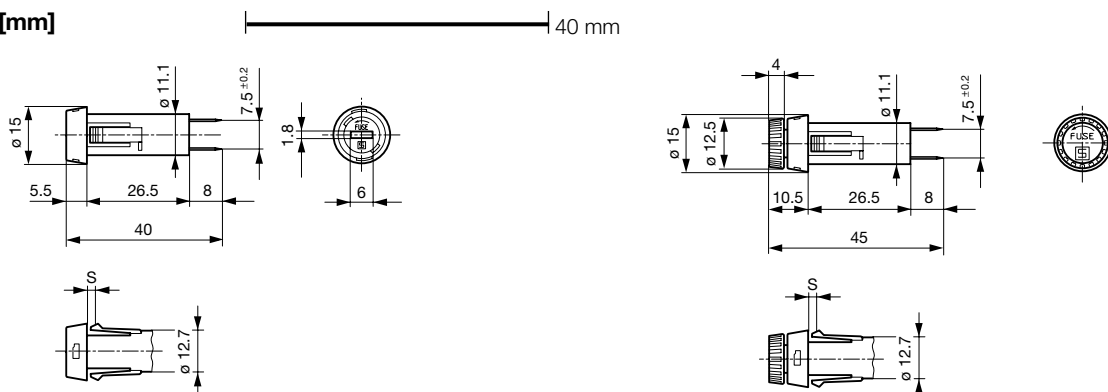

Variants 3101.0030, 3101.0230, 3101.0031 and 3101.0331  
 s = Panel thickness (see variants)

Variants Fingergrasp 3101.0035, 3101.0235, 3101.0036 and 3101.0336  
 s = Panel thickness (see variants)

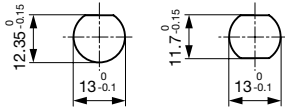

Mounting holes

### Derating Curves

acc. to IEC

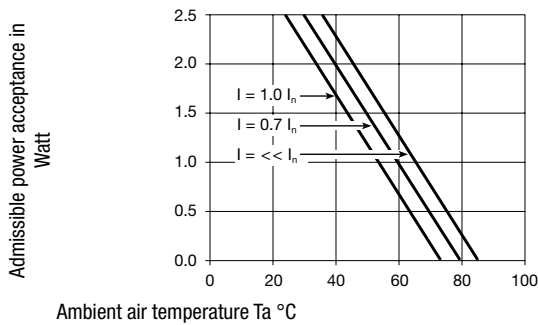

### All Variants

| Holder | Cap        | Panel Thicknesses [mm] | Terminal                   | Colour Holder | Material      | Order Number |
|--------|------------|------------------------|----------------------------|---------------|---------------|--------------|
| ●      | slotted    | 1.0 - 1.8mm            | Solder                     | black         | Thermoplastic | 3101.0030    |
| ●      | slotted    | 1.0 - 1.8mm            | Quick-Connect 4.8 x 0.5 mm | black         | Thermoplastic | 3101.0230    |
| ●      | slotted    | 2.0 - 3.0mm            | Solder                     | black         | Thermoplastic | 3101.0031    |
| ●      | slotted    | 2.0 - 3.0mm            | Quick-Connect 4.8 x 0.5 mm | black         | Thermoplastic | 3101.0331    |
| ●      | Fingergrip | 1.0 - 1.8mm            | Solder                     | black         | Thermoplastic | 3101.0035    |
| ●      | Fingergrip | 1.0 - 1.8mm            | Quick-Connect 4.8 x 0.5 mm | black         | Thermoplastic | 3101.0235    |
| ●      | Fingergrip | 2.0 - 3.0mm            | Solder                     | black         | Thermoplastic | 3101.0036    |
| ●      | Fingergrip | 2.0 - 3.0mm            | Quick-Connect 4.8 x 0.5 mm | black         | Thermoplastic | 3101.0336    |

Availability for all products can be searched real-time: <https://www.schurter.com/en/info-center/support-tools/stock-check-distributors>

### Packaging Unit

Bulk 186 x 91 x 91 mm (100 pcs.)