

Multibox 160A, DIN 00



See below:

Approvals and Compliances

Description

- Glass fiber Polyester
- Difficult to burn
- Impact resistant

Unique Selling Proposition

- Modern, practical design
- On request flush-mounted cover with stainless steel plate
- Thanks to only 117mm installation depth and insulation material, the insulated building envelope is not weakened when installed in flush-mounting
- Suitable for minergie standard

Characteristics

- With 3 x 1-pole fuse switch disconnecter
- Bolt lock (4-kant with Slot)
- Protection 2-piece, transparent and sealable
- N-connector for TN-C to TN-S
- N-connector separating Piece self-opening when loosening the screw
- Voltage test possible only if fuse with not insulated straps used
- Combintion possible
- Mounting type surface / flush

References

Alternative: Direct installation in concrete or other rated current [MULTI-BOX 63A](#); [MULTIBOX UPB 160A](#); [MULTIBOX UPB 63A](#)

Weblinks

[pdf data sheet](#), [html datasheet](#), [Detailed request for product](#), [Microsite](#)

Customer Specific Solutions

Whether surface or flush-mounted, with Multibox you always work with the same housings and fuse elements (60A) or switch-disconnectors (DIN00). The additional housings, which can be attached with one click, give you maximum flexibility with a minimum of effort.

Technical Data

Rated Current Ie	160A @ 500VAC
	125A@ 690VAC
Rated voltage Ue	690VAC
Rated isolation voltage Ui	1000VAC
Rated Power Operating Frequency fe	50Hz

Rated Impulse Withstand Voltage Uimp	8kV
Conditioned Rated Short Circuit Current	50kA @ 500VAC
Rated short-time withstand current with fuse links	20kA @ 500VAC
Allowed Ambient Temperature	-25°C to +40°C acc. to IEC 61439
Protection by closed housing	IP54

Terminals

NH-Fuse-Links with screw terminal for cable lug	M8
Fuse Element with double terminals strap	6 - 70mm ²

Neutral Disconnector with Straps	6 - 70mm ²
Earth Connection Bride	6 - 70mm ²
Double terminal	6 - 50mm ²
Earth Connection (outside)	M8

NH-Switch disconnecter

Fuse-Link	DIN 00
Rated Current Ie	160A @ 500VAC 125A @ 690VAC
Rated voltage Ue	690VAC 220VDC
Rated isolation voltage Ui	1000VAC
Rated Power Operating Frequency fe	50Hz
Rated Impulse Withstand Voltage Uimp	8kV
Conditioned Rated Short Circuit Current	80kA @ 500VAC 50kA @ 690VAC

Category of use AC	AC-23B @ 400VAC AC-22B @ 500VAC AC-21B @ 690VAC
Category of use DC	DC-22B @ 220VDC
Rated power dissipation without NH fuse-links at Ith	2.3 W
Protection class	IP20
Mechanical lifetime	1400 Insertions
Electrical lifetime	200 Insertions
Ambient Temperature Tu**)	-40°C to +55°C



**) A reduction of the rated current is required above 30°C

Approvals and Compliances

Detailed information on product approvals, code requirements, usage instructions and detailed test conditions can be looked up in [Details about Approvals](#)

Compliances

The product complies with following Guide Lines

Identification	Details	Initiator	Description
	CE declaration of conformity	SCHURTER AG	The CE marking declares that the product complies with the applicable requirements laid down in the harmonisation of Community legislation on its affixing in accordance with EU Regulation 765/2008.
	UKCA declaration of conformity	SCHURTER AG	The UKCA marking declares that the product complies with the applicable requirements laid down in the British Amendment of Regulation (EC) 765/2008.
	REACH	SCHURTER AG	On 1 June 2007, Regulation (EC) No 1907/2006 on the Registration, Evaluation, Authorization and Restriction of Chemicals 1 (abbreviated as "REACH") entered into force.

Assembly Instructions

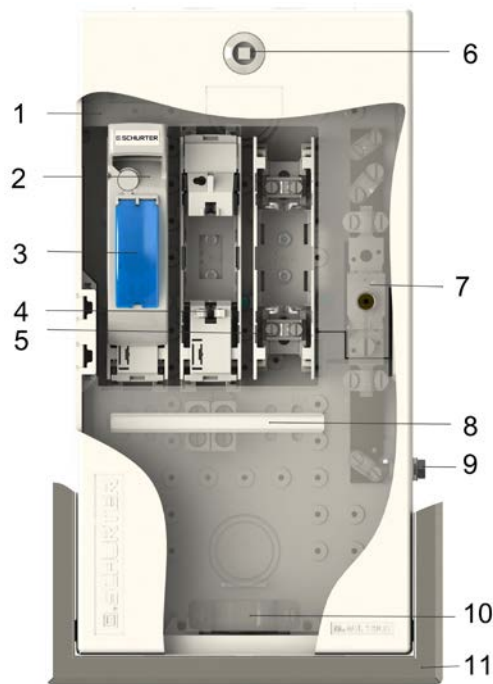

- 1. Cover Plate 2-piece, transparent and lockeable
- 2. NH-NH fuse load--breaker
- 3. Hinged window
- 4. Inner Cover
- 5. Various connection variants: clamp-Cable lug-Double terminals
- 6. Square lock
- 7. Neutral conductor isolator for TN-S/TN-C
- 8. Labeling field
- 9. External ground connection (optional)
- 10. Cable fixing (optional)
- 11. Front frame for UP mounting



12. 63A- Fuse element with different connection variants

Diagrams

TN-S (delivered condition)

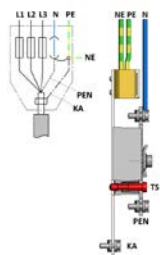

- L = Pole conductor
- PE = Protective conductorPEN = PEN conductor
- N = Neutral conductor
- NE = Neutral earth conductor
- TS = Separating screw
- KA = Cable armor

TN-C

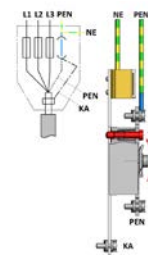

- L = Pole conductor
- PE = Protective conductorPEN = PEN conductor
- N = Neutral conductor
- NE = Neutral earth conductor
- TS = Separating screw
- KA = Cable armor

Order number key

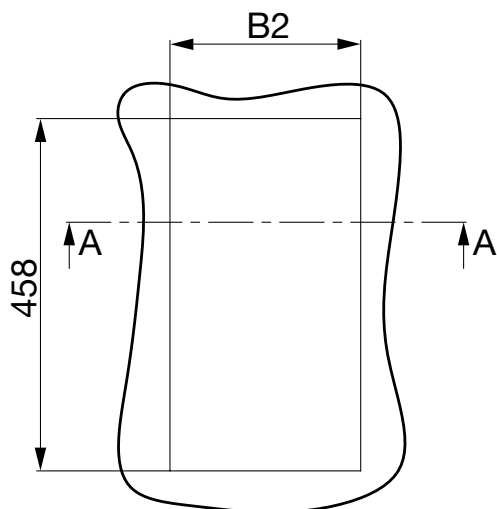
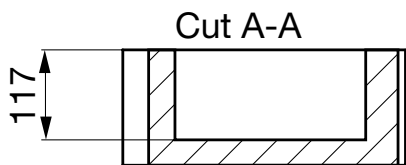
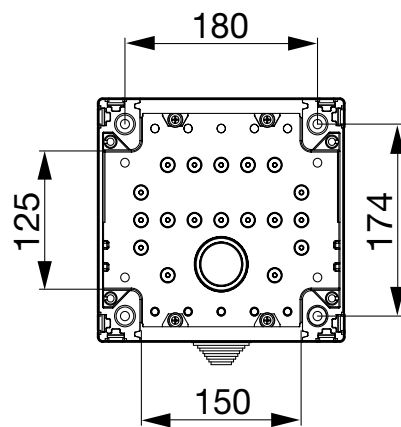
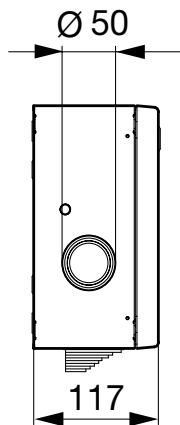
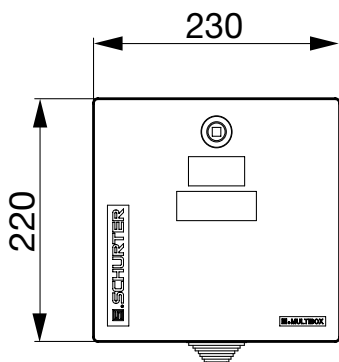
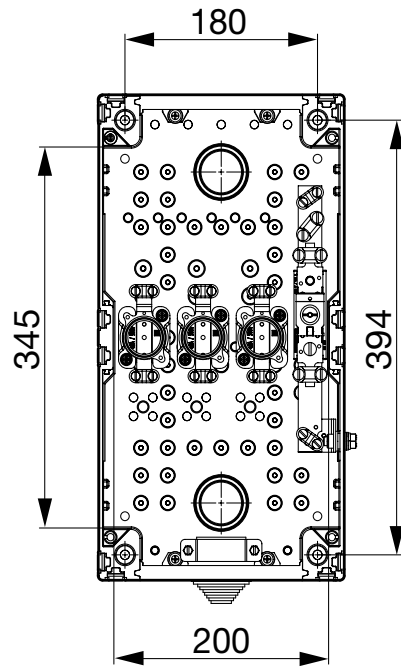
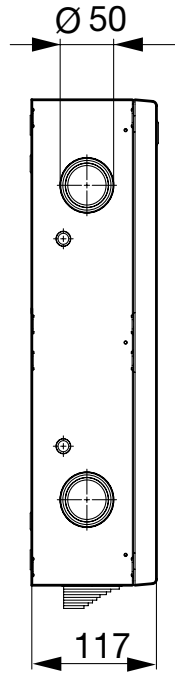
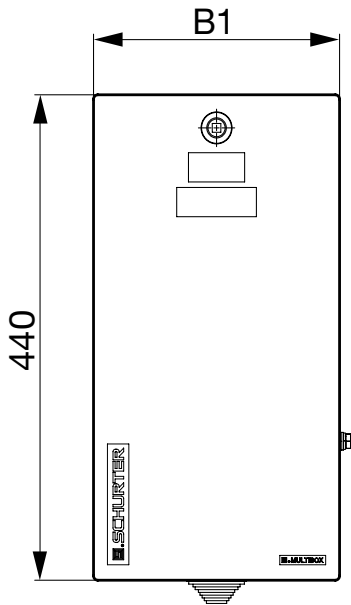

Version	B1	B2	Styrofoamblock
HAK	230	248	0011.9817
Combi 1+2	460	478	0011.9818
Combi 3+4	690	708	0011.9819
Combi 7	920	938	-

Installation with Styrofoamblock according to table

Mounting type

- 1= AP/ Surface-mounted with external earth
- 2= AP/ Surface-mounted without external earth
- 3= UP/ Flush-mounted without external earth, with building cover

Connection of the screw element and neutral disconnecter **Neutral disconnecter**

- 63 A
- 1= Inlet double strap / outlet double strap
 - 2= Inlet double terminal / outlet double strap
 - 5= Inlet screw / outlet terminal 70mm²
 - 6= Inlet double strap / outlet terminal 70mm²

- 1= 160 A/ TN-S/ TN-C

Accessories

			1	2	3	4	5	6	7	8	9	10	11	12	13	14	15	16	17	18	19
					X	X	X	X	X	X	X		X	X	X		X	X	X	X	X

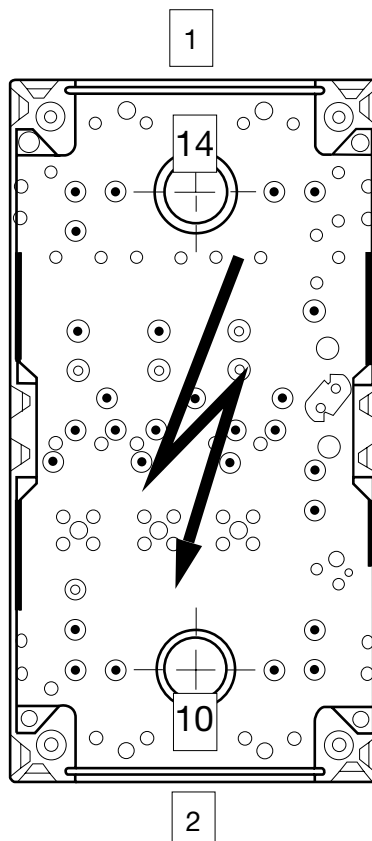

Mounting type

1= AP/ Surface-mounted without external earth
 2= UP/ Flush-mounted without external earth, with building cover

Neutral disconnecter

1= 160 A/ TN-S/ TN-C

Current

1= 63 A
 2= 160 A

Connection type of the element DIII / DIN0

63 A
 1= Inlet double strap / outlet double strap
 2= Inlet double terminal / outlet double strap

160 A
 3= Inlet terminal 70mm² / outlet terminal 70mm²
 4= Inlet screw / outlet terminal 70mm²
 5= Inlet screw / outlet screw
 6= Inlet double terminal / outlet terminal 70mm²

Accessories

<input type="checkbox"/>	<input type="checkbox"/>	<input type="checkbox"/>	<input type="checkbox"/>	1	2	3	4	5	6	7	8	9	10	11	12	13	14	15	16	17	18	19
<input type="checkbox"/>	<input type="checkbox"/>	<input type="checkbox"/>	<input type="checkbox"/>	<input type="checkbox"/>	<input type="checkbox"/>	<input type="checkbox"/>	<input type="checkbox"/>	X	X	X	X	X	<input type="checkbox"/>	<input type="checkbox"/>	X	X	<input type="checkbox"/>	<input type="checkbox"/>	X	X	X	<input type="checkbox"/>

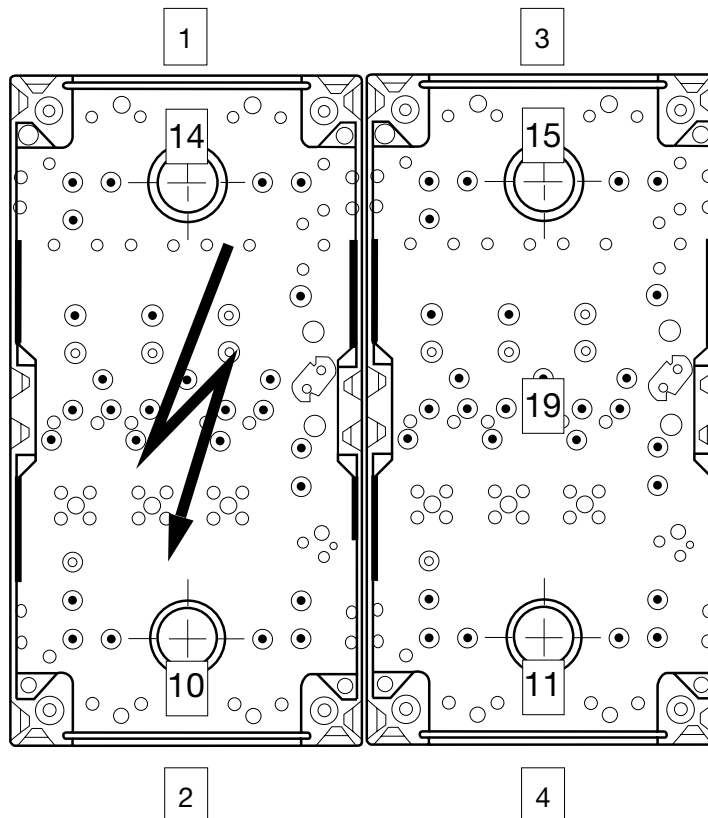

Mounting type

- 1= AP/ Surface-mounted without external earth
- 2= UP/ Flush-mounted without external earth, with building cover

Neutral disconnecter

- 1= 160 A/ TN-S/ TN-C

Current

- 1= 63 A
- 2= 160 A

Connection type of the element DIII / DIN0

- 63 A
- 1= Inlet double strap / outlet double strap
 - 2= Inlet double terminal / outlet double strap
- 160 A
- 3= Inlet terminal 70mm² / outlet terminal 70mm²
 - 4= Inlet screw / outlet terminal 70mm²
 - 5= Inlet screw / outlet screw
 - 6= Inlet double terminal / outlet terminal 70mm²

Accessories

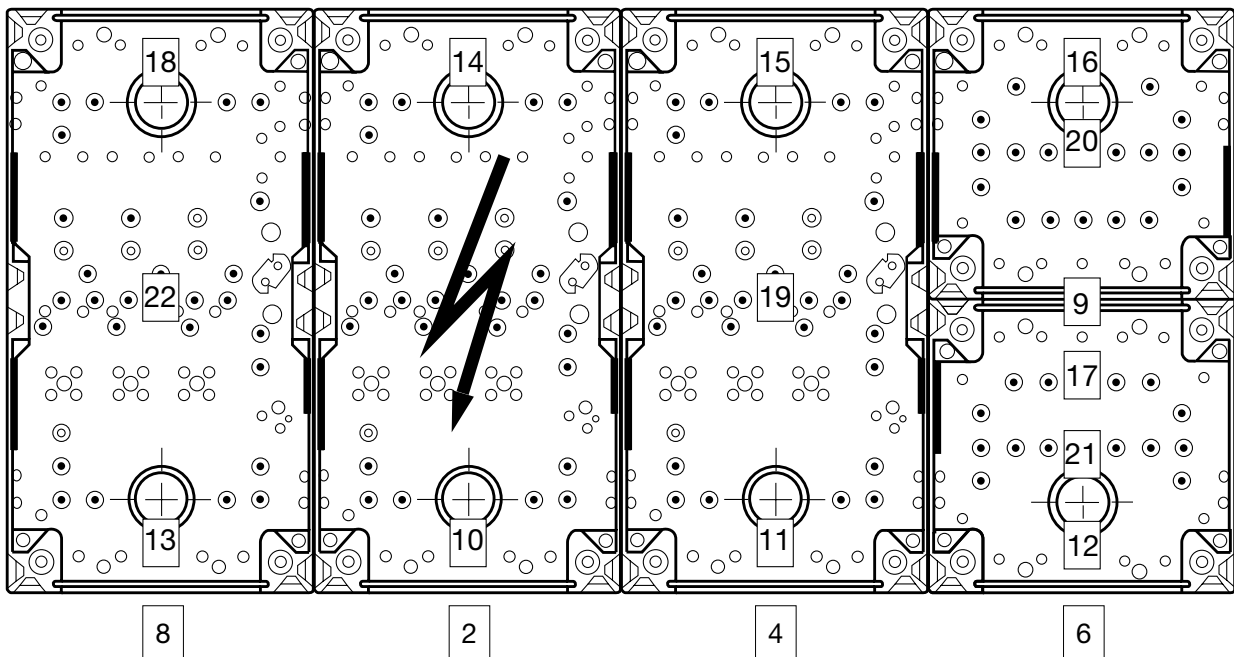
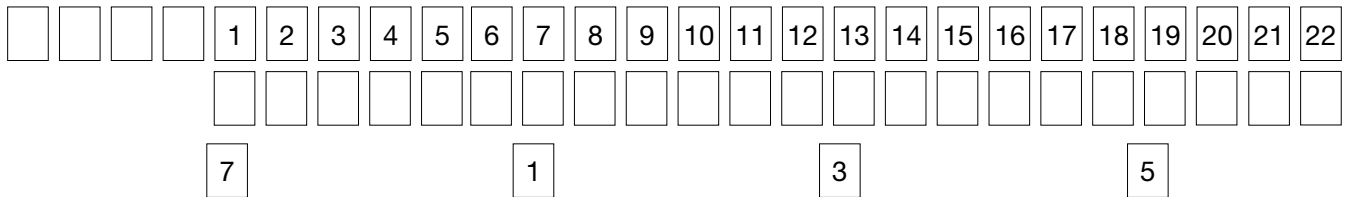

Andere Kombinationen sind möglich. Teilen Sie uns bitte Ihren Wunsch mit. Wir beraten Sie gerne.
 Ausführung mit Hochleistungsautomaten auf Anfrage.

Accessories



Cover
 No 1-9

- A = undrilled
- C = 2x stepped (compl.)
- D = 1x M40
- E = 1x M50
- F = 1x M63
- G = 2x M40
- H = 2x M50
- J = 2x M63
- K = 1x M40 + 1x M16
- M = 1x M50 + 1x M25
- N = 1x M63 + 1x M16
- O = 1x Ø 35mm

- AD = 1x Ø 35 mm + 1x Ø 16mm
- P = 2x Ø 35mm
- Q = 1x Ø 50mm
- R = 1x Ø 60mm
- AE = 2x Ø 60mm
- S = 1x Ø 55mm
- T = 1x stepped (compl.)
- V = 1x square
- X = 1x M16
- Y = 2x M25
- AB = 1x M25
- AA = 5x M25



Cable fixation with clamp and rubber
 No 10-13

- A = without cable fixation
- B = single clamp Ø 42mm
- C = single clamp Ø 24mm
- D = double clamp Ø 42mm
- E = double clamp Ø 24mm



Lock
 No 14-18

- C = with EMKA-Lock
- D = with KABA-Lock
- E = with 4-Kant 8x8 and slot



DIN-Rail / Monting panel
 No 19-22

- A = without DIN-Rail / Monting panel
- B = with DIN-Rail
- C = with Mounting panel



Front frame

- 1/1 0011.0901
- Combi 1+ 2 0011.0903
- Combi 3 + 4 0011.0904
- Combi 7 0011.0905

All Variants

Designation	Terminal	Order Number	E-No.
MULTIBOX AP HAK 160A DIN00+0+E	Straps	0009.5165	131DDAA ¹⁾
MULTIBOX AP HAK 160A DW DIN00+0+E	Double Terminal	0009.5167	161DGAA ¹⁾
MULTIBOX UP HAK 160A DIN00+0	Straps	0009.5166	331QQBA ¹⁾
MULTIBOX UP HAK 160A DW DIN00+0	Double Terminal	0009.5168	361QQBA ¹⁾

Availability for all products can be searched real-time: <https://www.schurter.com/en/info-center/support-tools/stock-check-distributors>

¹⁾ E-Nr. corrisponde to ordercode

Packaging unit

1 Pcs