

AC Filter Cost Optimized



See below:
[Approvals and Compliances](#)

Description

- Line filter in standard and medical version
- 1-stage
- standard attenuation

Characteristics

- Designed for universal industrial applications
- High attenuation at maximum resp. asymmetric load independent from the line impedance
- Protection against interference voltage from the mains
- Possible interferences generated in the equipment are strongly attenuated
- Especially designed for industrial applications such as: Frequency Converters, Stepper Motor Drives, UPS-Systems, Inverters
- Suitable for use in equipment according to IEC/UL 62368-1
- Suitable for use in medical equipment according to IEC/UL 60601-1 (1 MOOP, 1 MOPP)

Other versions on request

- Version with wire connection

References

Alternative: Standard version
We recommend for new applications the type [FMAB NEO](#)

Weblinks

[pdf data sheet](#), [html datasheet](#), [General Product Information](#), [Approvals](#), [Distributor-Stock-Check](#), [Detailed request for product](#), [Microsite](#)

Technical Data

| | |
|---------------------------------|-------------------------------------------------------------------------|
| Ratings IEC | 6 - 20 A @ Ta 40 °C / 250 VAC; 50Hz |
| Ratings UL/CSA | 6 - 20 A @ Ta 40 °C / 125 VAC; 60Hz |
| Leakage Current | standard < 0.35 mA (250V / 60 Hz) |
| Dielectric Strength | 1.7 kVDC between L-N 2.7 kVDC between L/N-PE Test voltage (2 sec) |
| Allowable Operation Temperature | -25 °C to 100 °C |
| Climatic Category | 25/100/21 acc. to IEC 60068-1 |
| Protection Class | Suitable for appliances with protection class I acc. to IEC 61140 |
| Terminal | Quick connect terminals 6.3 x 0.8 mm |
| Material | Nickel plated steel |

| | |
|-------------|--------------------------------------------------------------------------------------------------------|
| Line Filter | Standard and Medical Version, IEC 60939, UL 1283, CSA C22.2 no. 8 Technical Details |
| MTBF | > 200'000h acc. to MIL-HB-217 F |

Approvals and Compliances



Detailed information on product approvals, code requirements, usage instructions and detailed test conditions can be looked up in [Details about Approvals](#)

SCHURTER products are designed for use in industrial environments. They have approvals from independent testing bodies according to national and international standards. Products with specific characteristics and requirements such as required in the automotive sector according to IATF 16949, medical technology according to ISO 13485 or in the aerospace industry can be offered exclusively with customer-specific, individual agreements by SCHURTER.

Approvals



The approval mark is used by the testing authorities to certify compliance with the safety requirements placed on electronic products.

Approval Reference Type: FMLB

| Approval Logo | Certificates | Certification Body | Description |
|----------------------------------------------------------------------------------|---------------|--------------------|------------------------------|
|  | VDE Approvals | VDE | Certificate Number: 40004673 |
|  | UL Approvals | UL | UR File Number: E72928 |



Product standards

Product standards that are referenced

| Organization | Design | Standard | Description |
|----------------------------------------------------------------------------------|-----------------------|-----------------|--------------------------------------------------------------|
|  | Designed according to | IEC 60939 | Passive filters for suppressing electromagnetic interference |
|  | Designed according to | UL 1283 | Passive filters for suppressing electromagnetic interference |
|  | Designed according to | CSA C22.2 no. 8 | Electromagnetic interference (EMI) filters |







Application standards

Application standards where the product can be used

| Organization | Design | Standard | Description |
|----------------------------------------------------------------------------------|--------------------------------|----------------|--------------------------------------------------------------------------------------------------------|
|  | Suitable for applications acc. | IEC/UL 62368-1 | Audio/video, information and communication technology equipment - Part 1: Safety requirements |
|  | Suitable for applications acc. | IEC 60601-1 | Medical electrical equipment - Part 1: General requirements for basic safety and essential performance |

Compliances

The product complies with following Guide Lines

| Identification | Details | Initiator | Description |
|------------------------------------------------------------------------------------|--------------------------------|-------------|-------------------------------------------------------------------------------------------------------------------------------------------------------------------------------------------------------|
|  | CE declaration of conformity | SCHURTER AG | The CE marking declares that the product complies with the applicable requirements laid down in the harmonisation of Community legislation on its affixing in accordance with EU Regulation 765/2008. |
|  | UKCA declaration of conformity | SCHURTER AG | The UKCA marking declares that the product complies with the applicable requirements laid down in the British Amendment of Regulation (EC) 765/2008. |
|  | RoHS | SCHURTER AG | Directive RoHS 2011/65/EU, Amendment (EU) 2015/863 |
|  | China RoHS | SCHURTER AG | The law SJ / T 11363-2006 (China RoHS) has been in force since 1 March 2007. It is similar to the EU directive RoHS. |
|  | REACH | SCHURTER AG | On 1 June 2007, Regulation (EC) No 1907/2006 on the Registration, Evaluation, Authorization and Restriction of Chemicals 1 (abbreviated as "REACH") entered into force. |
|  | Medical Equipment | SCHURTER AG | Suitable for use in medical equipment according to IEC/UL 60601-1 (1 MOOP, 1 MOPP) |

Dimension [mm]

Case 49

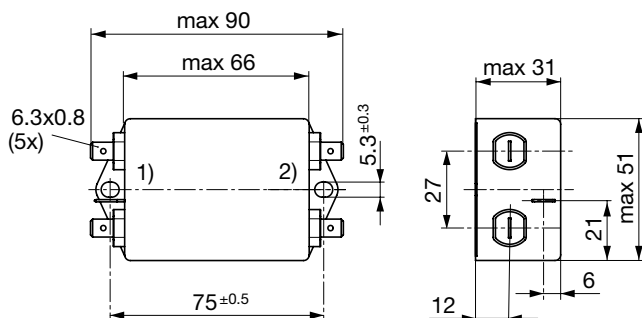

Diagrams

Standard Version or medical M80

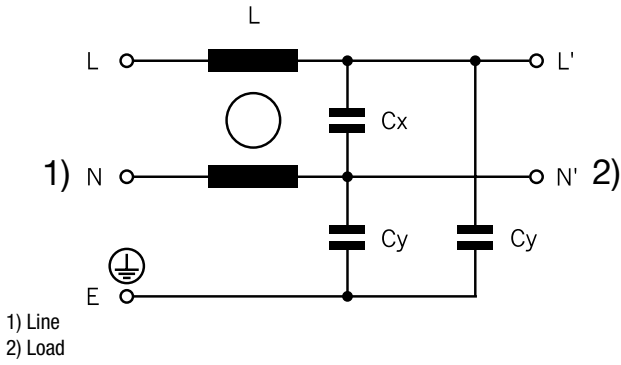

Medical Version (M5)

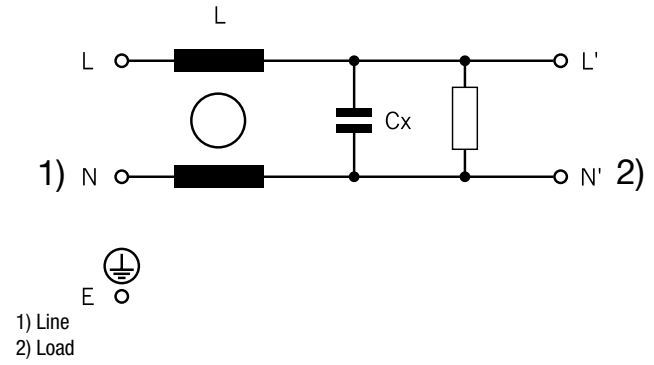

Attenuation Loss

----- 50Ω differential mode _____ 50Ω common mode

Standard version

6 A

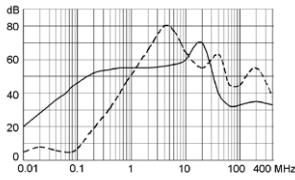

10 A

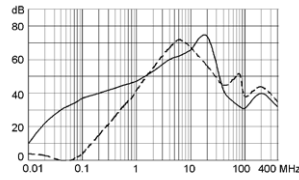

16 A

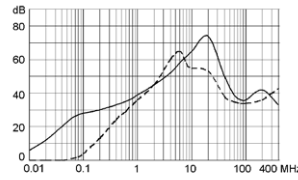

20 A

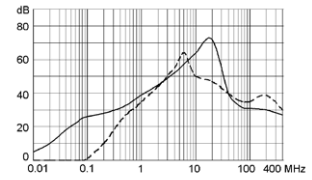

Medical version (M5)

6 A

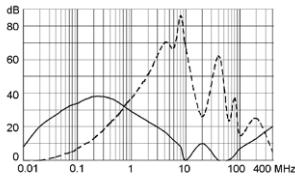

10 A

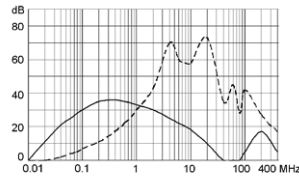

16 A

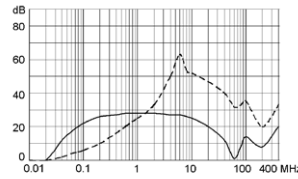

20 A

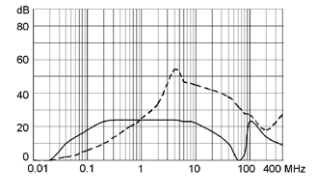

Medical version (M80)

6 A

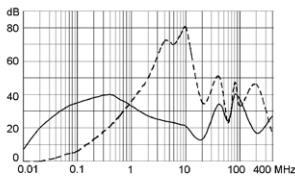

10 A

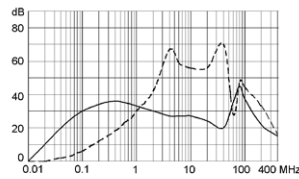

16 A

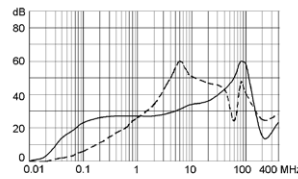

20 A

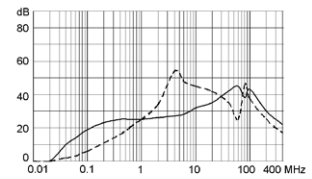

All Variants

| Rated Current [A] | Filter-Type | L [mH] | Cx (X2) [µF] | Cy (Y2) [nF] | Weight [g] | Housing | Order Number |
|-------------------|-----------------------|---------|--------------|--------------|------------|---------|--------------|
| 6 | Standard version | 2 x 14 | 0.1 | 3.3 | 212g | 49 | 5500.2035 |
| 10 | Standard version | 2 x 5 | 0.1 | 3.3 | 212g | 49 | 5500.2036 |
| 16 | Standard version | 2 x 2 | 0.1 | 3.3 | 208g | 49 | 5500.2037 |
| 20 | Standard version | 2 x 1.5 | 0.1 | 3.3 | 218g | 49 | 5500.2038 |
| 6 | Medical Version (M5) | 2 x 14 | 0.1 | - | 212g | 49 | 5500.2082 |
| 10 | Medical Version (M5) | 2 x 5 | 0.1 | - | 212g | 49 | 5500.2083 |
| 16 | Medical Version (M5) | 2 x 2 | 0.1 | - | 208g | 49 | 5500.2084 |
| 20 | Medical Version (M5) | 2 x 1.5 | 0.1 | - | 218g | 49 | 5500.2085 |
| 6 | Medical Version (M80) | 2 x 14 | 0.1 | 0.47 | 212g | 49 | 5500.2094 |

| Rated Current [A] | Filter-Type | L [mH] | Cx (X2) [µF] | Cy (Y2) [nF] | Weight [g] | Housing | Order Number |
|-------------------|-----------------------|---------|--------------|--------------|------------|---------|--------------|
| 10 | Medical Version (M80) | 2 x 5 | 0.1 | 0.47 | 212 g | 49 | 5500.2095 |
| 16 | Medical Version (M80) | 2 x 2 | 0.1 | 0.47 | 208 g | 49 | 5500.2096 |
| 20 | Medical Version (M80) | 2 x 1.5 | 0.1 | 0.47 | 218 g | 49 | 5500.2097 |

Availability for all products can be searched real-time: <https://www.schurter.com/en/info-center/support-tools/stock-check-distributors>

Packaging unit 10 Pcs
